

The Giovannini rotators, are designed for medium and very large antenna systems and the specifications that you read below are suitable for this. Monobanders for 40 or 80 meters , large HF antennas for 20 -15 -10 m , rotating tower, stacking of antennas... and more.

This antenna rotators are designed to be installed inside a tower or beside for a rotating tower or a mast.

Torque up to 1000 Nm , all models are supplied with torsionally **flexible** jaw coupling, square flange and a 230 Vac 50 Hz 0,18 Kw electric motor (115 V ac 60 Hz UL on request). The heavy duty mast clamp is supplied on request.

Smart digital control unit and separately power unit are supplied, for computer and remote control , by the internet or LAN.

GE 4000 NS

Torque : 1001 Nm
Kg. **74** 163 lbs



GE 2500 NS

Torque : 625 Nm
Kg. **38** 84 lbs



GE 1500 NS

Torque : 220 Nm
Kg. **27** 60 lbs

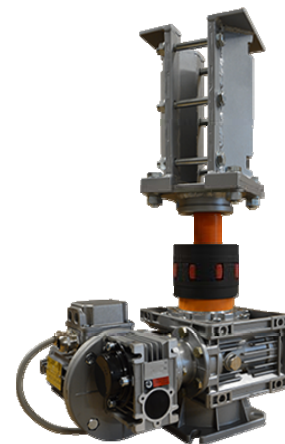

Digital control unit

130 x 140 x H 50 mm
5.12 x 5.51 x H 1.97 in



Power unit

235 x 235 x H 90 mm
9.25 x 9.25 x H 3.54 in

Specifications	Mod. 1500 NS	Mod. 2500 NS	Mod. 4000 NS
Power Torque	220 Nm	625 Nm	1001 Nm
Brake Torque	440 Nm	1250 Nm	2002 Nm
Mast clamp Up to 90 mm (3" 17/32) <i>ON REQUEST</i>	48–76 mm (1" 1/2 –2" 1/2) Or square flange 160x160 mm 6.3 x 6.3 in	48–76 mm (1" 1/2 –2" 1/2) Or square flange 160x160 mm 6.3 x 6.3 in	48–76 mm (1" 1/2 –2" 1/2) Or square flange 160x160 mm 6.3 x 6.3 in
Rotation speed , for 360°	120"	120"	120"
Rotation range	540°	540°	540°
Accuracy	± 1°	± 1°	± 1°
Motor power	0.18 Kw	0.18 Kw	0.18 Kw
Main power	230 Vac 50 Hz 115 V ac 60 Hz on request	230 Vac 50 Hz 115 V ac 60 Hz on request	230 Vac 50 Hz 115 V ac 60 Hz on request
Cable cores	6 wires	6 wires	6 wires
	USB	RS 232	"LAN on request"
Digital control unit weight	Kg. 0.8 1.7 lbs	Kg. 0.8 1.7 lbs	Kg. 0.8 1.7 lbs
Power unit weight	Kg. 2.3 5 lbs	Kg. 2.3 5 lbs	Kg. 2.3 5 lbs
Rotator weight	Kg. 27 60 lbs	Kg. 38 84 lbs	Kg. 74 163 lbs
Shipping measures	41x35xH52 cm double carton box 16.2x13.8xH20.5 in	40x33xH62 cm double carton box 16x13xH24.4 in	47x41xH72 cm wood case 18.5x16xH28.4 in
Shipping weight	33 Kg 73 lbs	45 Kg 99 lbs	86 Kg 190 lbs

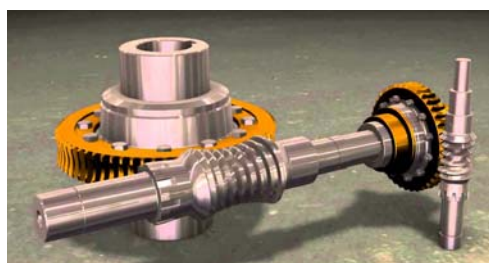

Double worm gear technology irreversible under wind load

Aluminium gear box for 1500 and 2500 models and cast iron for 4000

Torsionally **flexible** jaw coupling

RAL 9022 aluminium colour

Temperature range : - 25 °C + 50 °C



Totally water protection

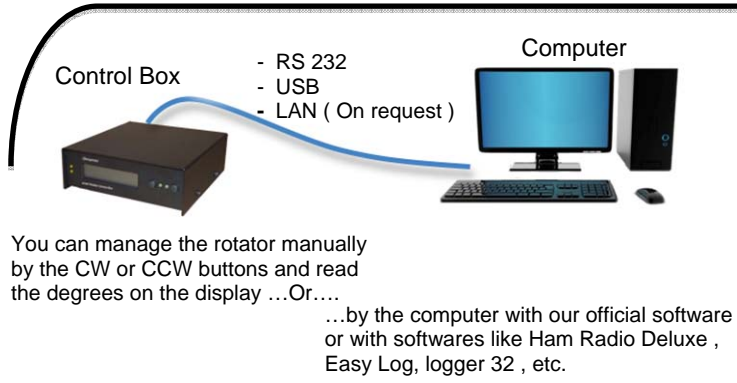
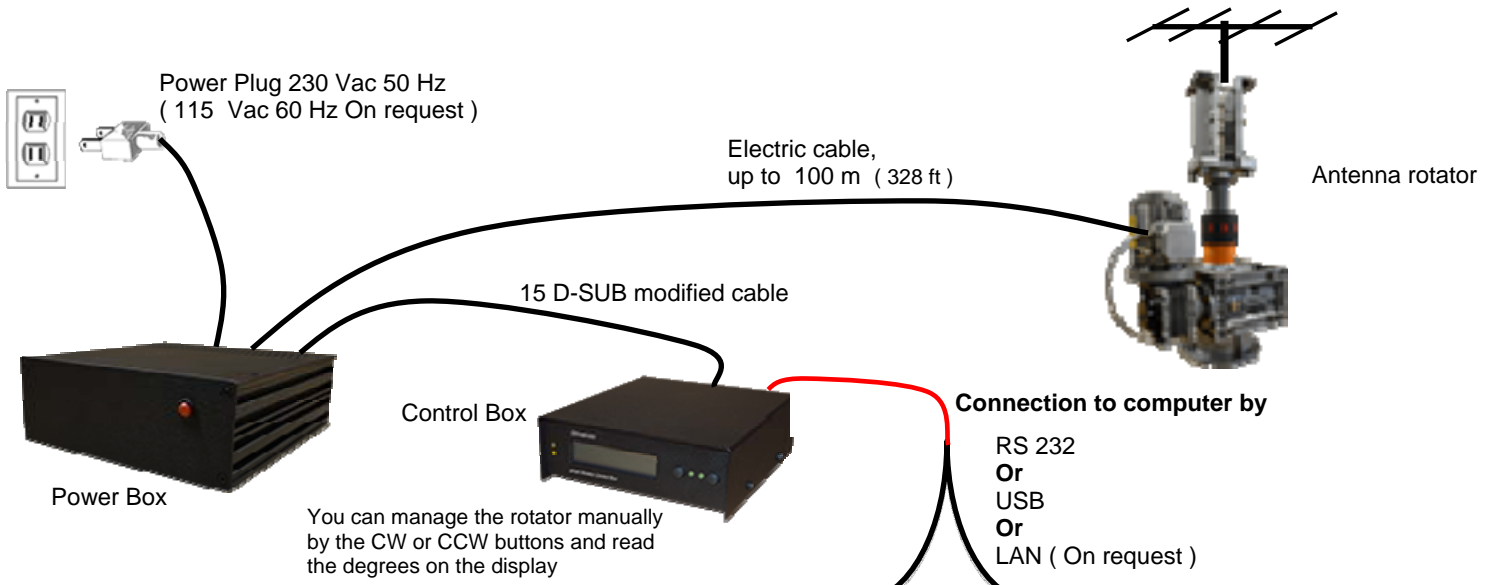

Our official software

How managing the rotator:

- by clicking on the right or left arrow.
- inserting the number of degrees directly from the keyboard and pressing "GO"
- clicking directly on the preferred position of the compass rose.

You can see the degrees in the top left of the window.
To stop the rotator just press "STOP"

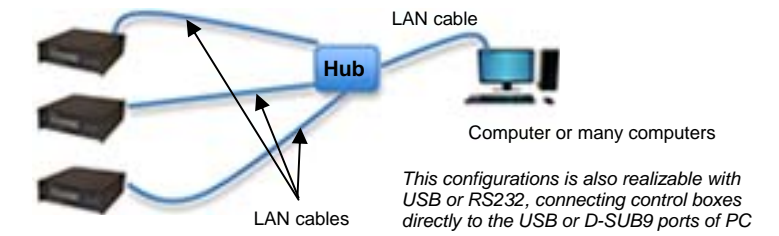
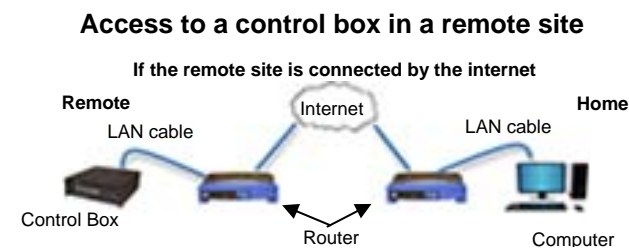
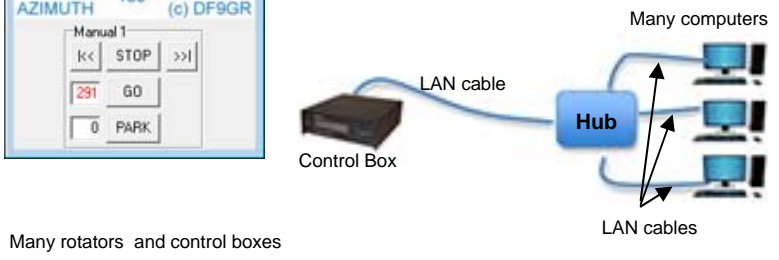
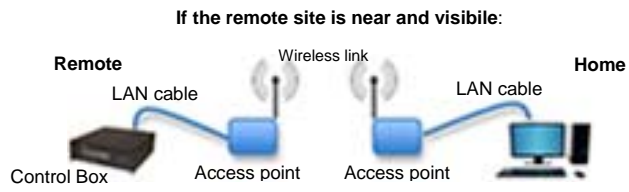

You may also use softwares like TeamViewer for remote a Control Box without LAN
Smart Rotator Control Box is compatible with RS232-over-ethernet devices on the market.

mm in	1500 NS		2500 NS		4000 NS	
A	285	11.3	355	14	420	16.5
B	180	7	380	15	420	16.5
C	630	24.8	745	29.3	790	31.1
D	445	17.5	510	20	520	20.5
E	255	10	250	9.8	300	11.8
F	166	6.5	170	6.7	170	6.7
G	102	4	136	5.36	168	6.6
I	72	2.8	102	4	127	5
L	Ø 180	7	Ø 210	8.27	Ø 280	11
S	144	5.7	206	8.1	253	9.96
T	174	6.85	238	9.37	295	11.6
U	290	11.4	360	14.2	425	16.7
Y	255	10	165	6.5	180	7.1
Z	103	4	130	5.1	145	5.7
M	160	6.3	160	6.3	160	6.3
H	180	7.1	180	7.1	180	7.1
Rotators plates holes diagram						
Holes	N° 4 Ø 11		N° 4 Ø 15		n° 8 Ø 13	
	7/16		19/32		1/2	
Ø P	Ø 150	5.9	Ø 175	6.89	Ø 230	9.1
Ø R	Ø 120	4.7	Ø 120	4.7	Ø 120	4.7

